



Product Type: Direct crimp connectors

Product Name:DL508H30F-03-0200

Product Description: Crosssection:0.08-0.2mm²/28-24AWG Ratedcurrent:4A CE

Product Size

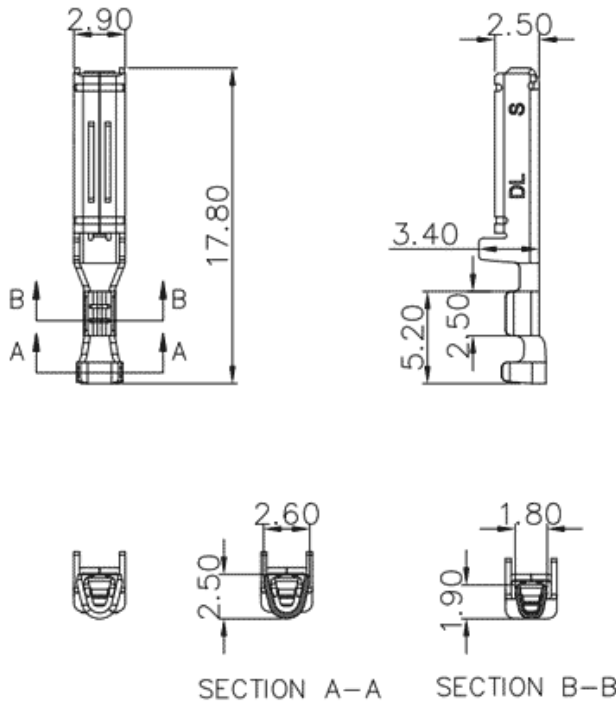

Parameters

⌘ SUPU ID	DL508H30F-03-0200
⌘ Pitch	-
⌘ Number of levels	-
⌘ Number of connections	-

☞ Connection method	Cold pressing
☞ Protection Level	IP20
☞ Operating temperature range	-40~+105°C
☞ Insulation material	-
☞ Insulation material group	-
☞ Contact material	Copper alloy
☞ Contact plating	Sn,Plated

Technical data

☞ IEC Rated Current	4A
☞ IEC Rated Voltage	-
☞ Overvoltage category	III/III/II
☞ Degree of pollution	-
☞ Rated impulse voltage	-
☞ UL Rated Current	4A
☞ UL Rated Voltage	-
☞ Conductor cross section rigid	-
☞ Conductor cross section flexible	0.08-0.2mm ²
☞ Conductor cross section flexible,with ferrule	-
☞ Locking screw Specification	-
☞ Locking screw torque	-
☞ Fixed Screw Specification	-
☞ 固定螺钉扭矩	-
☞ Stripping length	4-5mm

☞ Use group

-

☞ Rated cross section

28-24AWG

Commercial data

☞ Order No

DL508H30F-03-0200

Ningbo SUPU Electronics Co., Ltd.

Address: No. 150, Xinxing 4th Road, High-tech Industrial Development Zone,
Cixi City, Zhejiang Province, China

Zip code: 315303

Switchboard: +86 574-63288158

Fax: +86 574-63288170

E-mail:supucontact@supu.cn

Service Hotline: 400-626-6336



Wechat

Date:2026-05-04 09:31

The right to modify data belongs to SUPU.