

Product Type: Direct crimp connectors

Product Name:DL508H1XXM-
BK-0Y10

Product Description: Pitch:5.08mm

RatedVoltage : 600V Single-level CE

Product Size

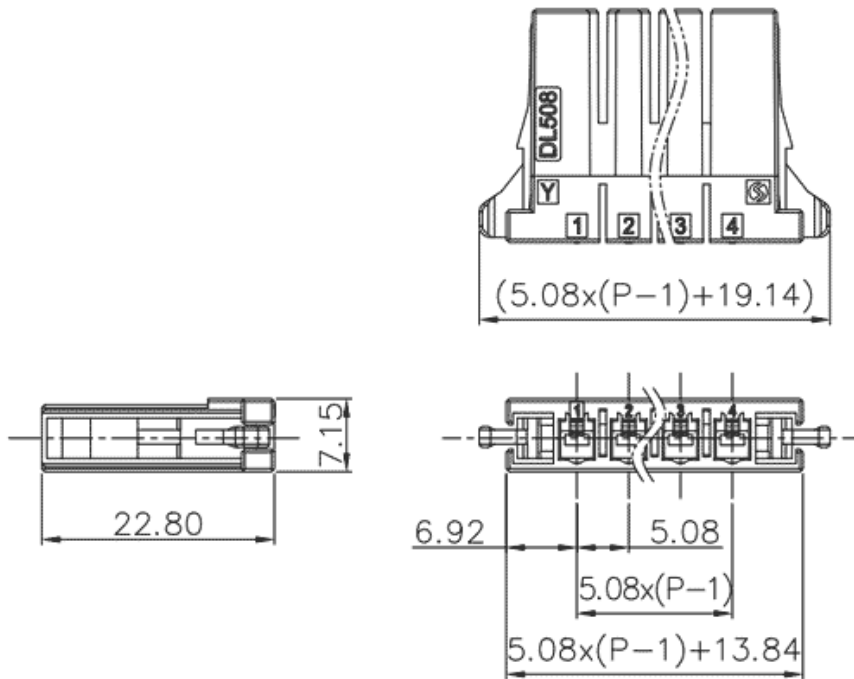

Parameters

☞ SUPU ID	DL508H1XXM-BK-0Y10
☞ Pitch	5.08
☞ Number of levels	Single layer
☞ Number of connections	XX

☞ Connection method	Cold pressing
☞ Protection Level	IP20
☞ Operating temperature range	-40~+105°C
☞ Insulation material	PBT
☞ Insulation material group	II
☞ Contact material	-
☞ Contact plating	-

Technical data

☞ IEC Rated Current	-
☞ IEC Rated Voltage	320V
☞ Overvoltage category	III/III/ II
☞ Degree of pollution	3 2 2
☞ Rated impulse voltage	4KV 4KV 4KV
☞ UL Rated Current	-
☞ UL Rated Voltage	600V
☞ Conductor cross section rigid	-
☞ Conductor cross section flexible	-
☞ Conductor cross section flexible,with ferrule	-
☞ Locking screw Specification	-
☞ Locking screw torque	-
☞ Fixed Screw Specification	-
☞ 固定螺钉扭矩	-
☞ Stripping length	-

☞ Use group -

☞ Rated cross section -

Commercial data

☞ Order No

DL508H1XXM-BK-0Y10

Ningbo SUPU Electronics Co., Ltd.

Address: No. 150, Xinxing 4th Road, High-tech Industrial Development Zone,
Cixi City, Zhejiang Province, China

Zip code: 315303

Switchboard: +86 574-63288158

Fax: +86 574-63288170

E-mail:supucontact@supu.cn

Service Hotline: 400-626-6336



Wechat

Date:2026-06-15 09:47

The right to modify data belongs to SUPU.