



Product Type: Direct crimp connectors

Product Name:DL381H2XXM-
BK-0Y10

Product Description: Pitch:3.81mm

RatedVoltage : 250V Double-level CE

Product Size

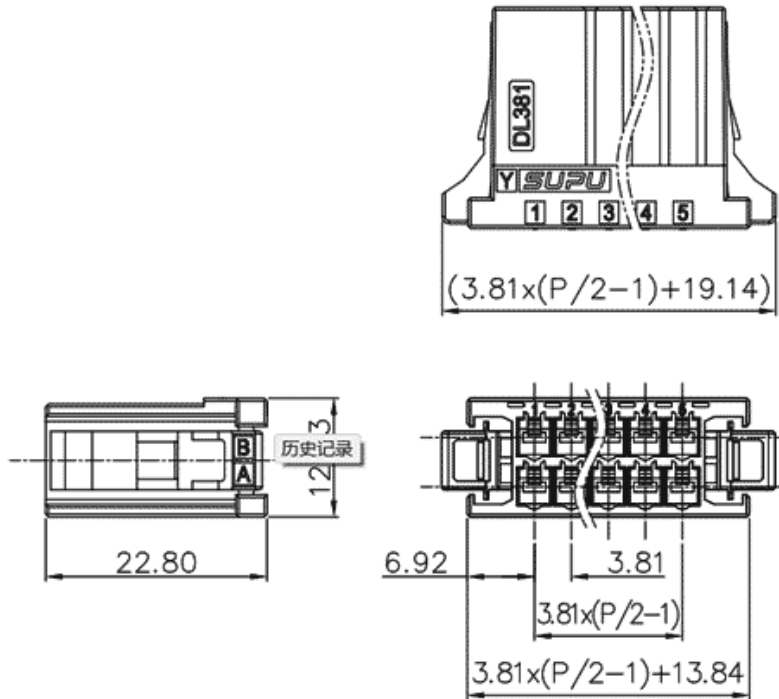

Parameters

☞ SUPU ID	DL381H2XXM-BK-0Y10
☞ Pitch	3.81
☞ Number of levels	Multiple layer
☞ Number of connections	XX

☞ Connection method	Cold pressing
☞ Protection Level	IP20
☞ Operating temperature range	-40~+105°C
☞ Insulation material	PBT
☞ Insulation material group	II
☞ Contact material	-
☞ Contact plating	-

Technical data

☞ IEC Rated Current	-
☞ IEC Rated Voltage	160V
☞ Overvoltage category	III/III/ II
☞ Degree of pollution	3 2 2
☞ Rated impulse voltage	2.5KV 2.5KV 2.5KV
☞ UL Rated Current	-
☞ UL Rated Voltage	250V
☞ Conductor cross section rigid	-
☞ Conductor cross section flexible	-
☞ Conductor cross section flexible,with ferrule	-
☞ Locking screw Specification	-
☞ Locking screw torque	-
☞ Fixed Screw Specification	-
☞ 固定螺钉扭矩	-
☞ Stripping length	-

☞ Use group -

☞ Rated cross section -

Commercial data

☞ Order No

DL381H2XXM-BK-0Y10

Ningbo SUPU Electronics Co., Ltd.

Address: No. 150, Xinxing 4th Road, High-tech Industrial Development Zone,
Cixi City, Zhejiang Province, China

Zip code: 315303

Switchboard: +86 574-63288158

Fax: +86 574-63288170

E-mail:supucontact@supu.cn

Service Hotline: 400-626-6336



Wechat

Date:2026-04-28 20:16

The right to modify data belongs to SUPU.