

Product Type: Plug-in terminal-socket

Product Name:MC-PC5.08V03C-T-0001

Product Description: Pitch: 5.08mm Rated Voltage : 320V Rated Current: 12A Connection method : Screw connection colour : customizable

### Product Size

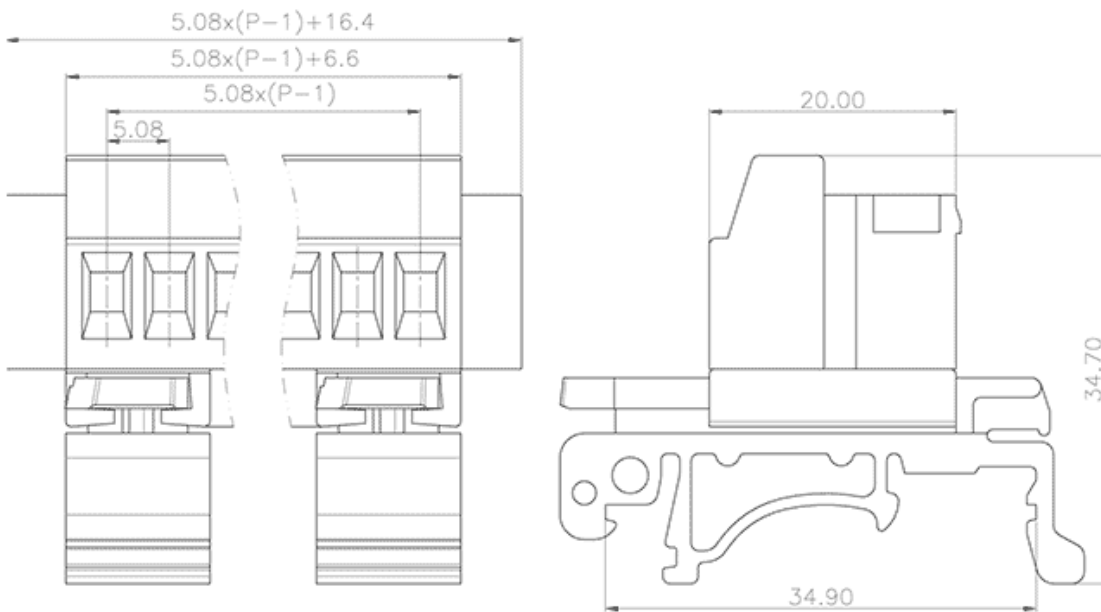

### Parameters

<input checked="" type="checkbox"/> SUPU ID	MC-PC5.08V03C-T-0001
<input checked="" type="checkbox"/> Pitch	5.08
<input checked="" type="checkbox"/> Number of levels	Single layer
<input checked="" type="checkbox"/> Number of connections	3

<input type="checkbox"/> Connection method	Screw connection
<input type="checkbox"/> Protection Level	IP20
<input type="checkbox"/> Operating temperature range	-40~+105°C
<input type="checkbox"/> Insulation material	PA66
<input type="checkbox"/> Insulation material group	I
<input type="checkbox"/> Contact material	Copper alloy
<input type="checkbox"/> Contact plating	Sn,Plated
<input type="checkbox"/> Color	Green/Black/Blue/Grey/Orange/Red

## Technical data

<input type="checkbox"/> IEC Rated Current	320V
<input type="checkbox"/> IEC Rated Voltage	12A
<input type="checkbox"/> Overvoltage category	III III II
<input type="checkbox"/> Degree of pollution	3 2 2
<input type="checkbox"/> Rated impulse voltage	4.0KV 4.0KV 4.0KV
<input type="checkbox"/> UL Rated Current	15A - 10A
<input type="checkbox"/> UL Rated Voltage	300V - 300V
<input type="checkbox"/> Conductor cross section rigid	0.2-2.5mm <sup>2</sup>
<input type="checkbox"/> Conductor cross section flexible	0.2-2.5mm <sup>2</sup>
<input type="checkbox"/> Conductor cross section flexible,with ferrule	0.2-2.5mm <sup>2</sup>
<input type="checkbox"/> Locking screw Specification	M3
<input type="checkbox"/> Locking screw torque	0.5-0.6N.m
<input type="checkbox"/> Stripping length	7-8mm
<input type="checkbox"/> Use group	B/C/D

☒ Rated cross section

28~12AWG

## Commercial data

☒ Order No

MC-PC5.08V03C-T-0001

### Ningbo SUPU Electronics Co., Ltd.

Address: No. 150, Xinxing 4th Road, High-tech Industrial Development Zone,  
Cixi City, Zhejiang Province, China

Zip code: 315303

Switchboard: +86 574-63288158

Fax: +86 574-63288170

E-mail:supucontact@supu.cn

Service Hotline: 400-626-6336

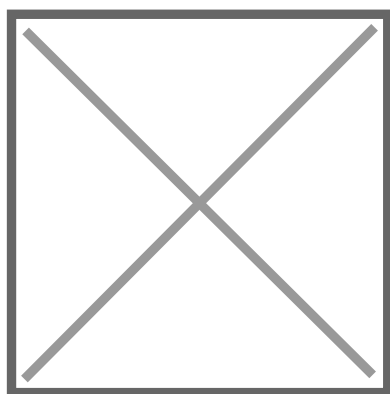

Wechat

Date:2026-05-05 09:37

The right to modify data belongs to SUPU.