

Product Type: Plug-in terminal-socket

Product Name:MC-PC5.08V19C-SF-0001

Product Description: Pitch: 5.08mm Rated Voltage : 320V Rated Current: 12A Connection method : Screw connection colour : customizable

Product Size

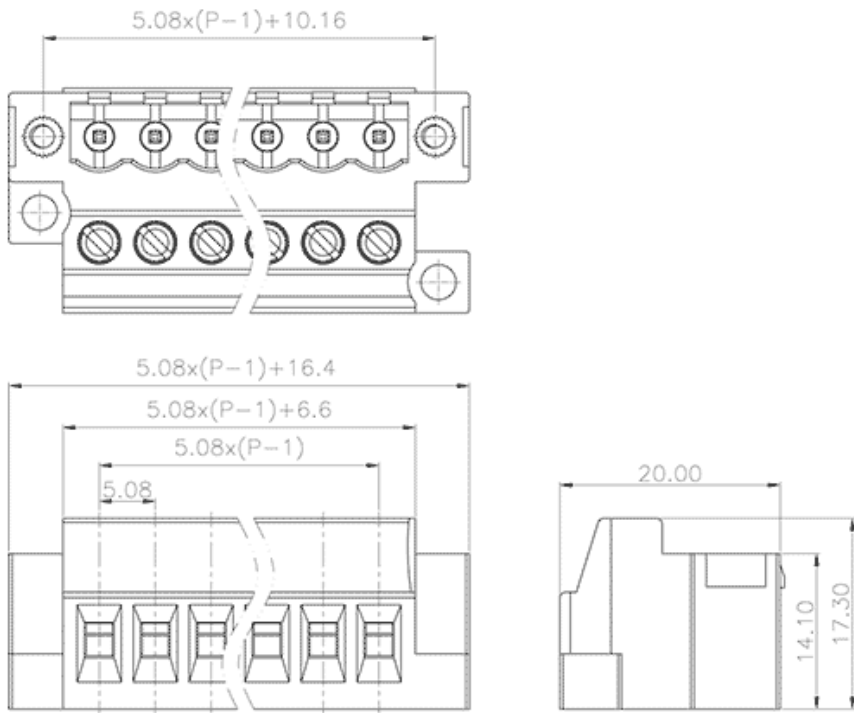

Parameters

|                         |                       |
|-------------------------|-----------------------|
| ☞ SUPU ID               | MC-PC5.08V19C-SF-0001 |
| ☞ Pitch                 | 5.08                  |
| ☞ Number of levels      | Single layer          |
| ☞ Number of connections | 19                    |

|                               |                                  |
|-------------------------------|----------------------------------|
| ☞ Connection method           | Screw connection                 |
| ☞ Protection Level            | IP20                             |
| ☞ Operating temperature range | -40~+105°C                       |
| ☞ Insulation material         | PA66                             |
| ☞ Insulation material group   | I                                |
| ☞ Contact material            | Copper alloy                     |
| ☞ Contact plating             | Sn,Plated                        |
| ☞ Color                       | Green/Black/Blue/Grey/Orange/Red |

## Technical data

|   |                        |
|---|------------------------|
| ☞ IEC Rated Current                             | 320V                   |
| ☞ IEC Rated Voltage                             | 12A                    |
| ☞ Overvoltage category                          | III III II             |
| ☞ Degree of pollution                           | 3 2 2                  |
| ☞ Rated impulse voltage                         | 4.0KV 4.0KV 4.0KV      |
| ☞ UL Rated Current                              | 15A - 10A              |
| ☞ UL Rated Voltage                              | 300V - 300V            |
| ☞ Conductor cross section rigid                 | 0.2-2.5mm <sup>2</sup> |
| ☞ Conductor cross section flexible              | 0.2-2.5mm <sup>2</sup> |
| ☞ Conductor cross section flexible,with furrule | 0.2-2.5mm <sup>2</sup> |
| ☞ Locking screw Specification                   | M3                     |
| ☞ Locking screw torque                          | 0.5-0.6N.m             |
| ☞ Stripping length                              | 7-8mm                  |
| ☞ Use group                                     | B/C/D                  |

Commercial data

☞ Order No

MC-PC5.08V19C-SF-0001

Ningbo SUPU Electronics Co., Ltd.

Address: No. 150, Xinxing 4th Road, High-tech Industrial Development Zone,  
Cixi City, Zhejiang Province, China

Zip code: 315303

Switchboard: +86 574-63288158

Fax: +86 574-63288170

E-mail:supucontact@supu.cn

Service Hotline: 400-626-6336



Wechat