

Product Type: Fixed terminal

Product Name:MC-TC2.54H20P-N-0001

Product Description: Pitch:2.54mm Rated Voltage : 160V Rated Current:6A Connection method : Push-in spring connection colour : customizable

Product Size

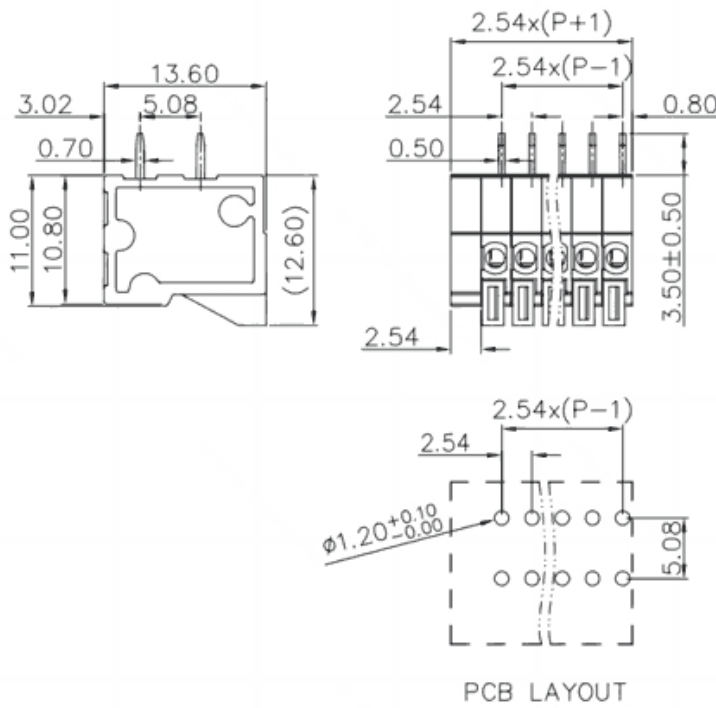

Parameters

⌘ SUPU ID	MC-TC2.54H20P-N-0001
⌘ Pitch	2.54
⌘ Number of levels	Single layer
⌘ Number of connections	20

☞ Connection method	Push in connection
☞ Protection Level	IP20
☞ Operating temperature range	-40~+105°C
☞ Insulation material	PA66
☞ Insulation material group	I
☞ Contact material	Copper alloy
☞ Contact plating	Sn,Plated
☞ Color	Green/Black/Blue/Grey/Orange/Red

Technical data

☞ IEC Rated Current	6A
☞ IEC Rated Voltage	160V
☞ Overvoltage category	III/III/ II
☞ Degree of pollution	3 2 2
☞ Rated impulse voltage	2.5KV 2.5KV 2.5KV
☞ UL Rated Current	5A - -
☞ UL Rated Voltage	150V - -
☞ Conductor cross section rigid	0.2-1.0mm ²
☞ Conductor cross section flexible	0.2-1.0mm ²
☞ Conductor cross section flexible,with furrule	0.2-1.0mm ²
☞ Locking screw Specification	-
☞ Locking screw torque	-
☞ Fixed Screw Specification	-
☞ Stripping length	11mm

☞ Order No

MC-TC2.54H20P-N-0001

Ningbo SUPU Electronics Co., Ltd.

Address: No. 150, Xinxing 4th Road, High-tech Industrial Development Zone,
Cixi City, Zhejiang Province, China

Zip code: 315303

Switchboard: +86 574-63288158

Fax: +86 574-63288170

E-mail:supucontact@supu.cn

Service Hotline: 400-626-6336



Wechat