

Product Type: Screw terminal

Product Name:306911

Product Description: Connection method:Screw connection,IEC Rated current:41A,IEC Rated Voltage:400V,Number of connections:2,Number of levels : 1,Rated cross section:26-8AWG

Product Size

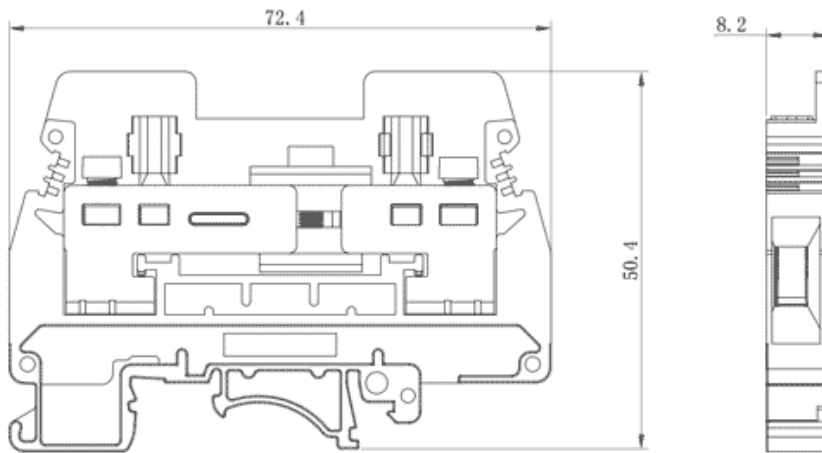

Parameters

☞ SUPU ID	306911
☞ Width	8.2mm
☞ Number of levels	1
☞ Number of connections	2

☞ Connection method	Screw connection
☞ Protection Level	IP20
☞ Insulation material	PA66
☞ Insulation material group	I
☞ Contact material	Copper alloy
☞ Contact plating	Ni,Plated
☞ Ambient temperature (operation)	-40°C~105°C
☞ Ambient temperature (assembly)	-5°C~70°C
☞ Ambient temperature (storage)	-25°C~60°C
☞ Permissible humidity (storage/transport)	30%~70%
☞ Product type	Test terminal block

Technical data

☞ IEC Rated Current	41A
☞ IEC Rated Voltage	400V
☞ Overvoltage category	III
☞ Degree of pollution	3
☞ Rated impulse voltage	6kV
☞ UL Rated Current	50A
☞ UL Rated Voltage	300V
☞ Conductor cross section rigid	0.5-10mm ²
☞ Conductor cross section flexible	0.5-6mm ²
☞ Conductor cross section flexible,with ferrule	0.5-4mm ²
☞ Locking screw Specification	M4

☞ Locking screw torque	1.2-1.5N.m
☞ Fixed Screw Specification	M3
☞ 固定螺钉扭矩	0.6-0.8N.m
☞ Stripping length	13-14mm
☞ Use group	B/C
☞ Rated cross section	26-8AWG
☞ UL Rated Current	50A
☞ UL Rated Current	300V

Commercial data

☞ Order No	306911
------------	--------

Ningbo SUPU Electronics Co., Ltd.

Address: No. 150, Xinxing 4th Road, High-tech Industrial Development Zone,

Cixi City, Zhejiang Province, China

Zip code: 315303

Switchboard: +86 574-63288158

Fax: +86 574-63288170

E-mail:supucontact@supu.cn

Service Hotline: 400-626-6336



Date:2026-05-04 09:29

The right to modify data belongs to SUPU.