



Product Type: M12 Field-assembly Connector

Product Name:M12A08Z-FASRAUA

Product Description: M12A-Assembly welded type, straight female 8-core, unshielded, the diameter of the adapter wire is 3.5-6.0MM

Product Size

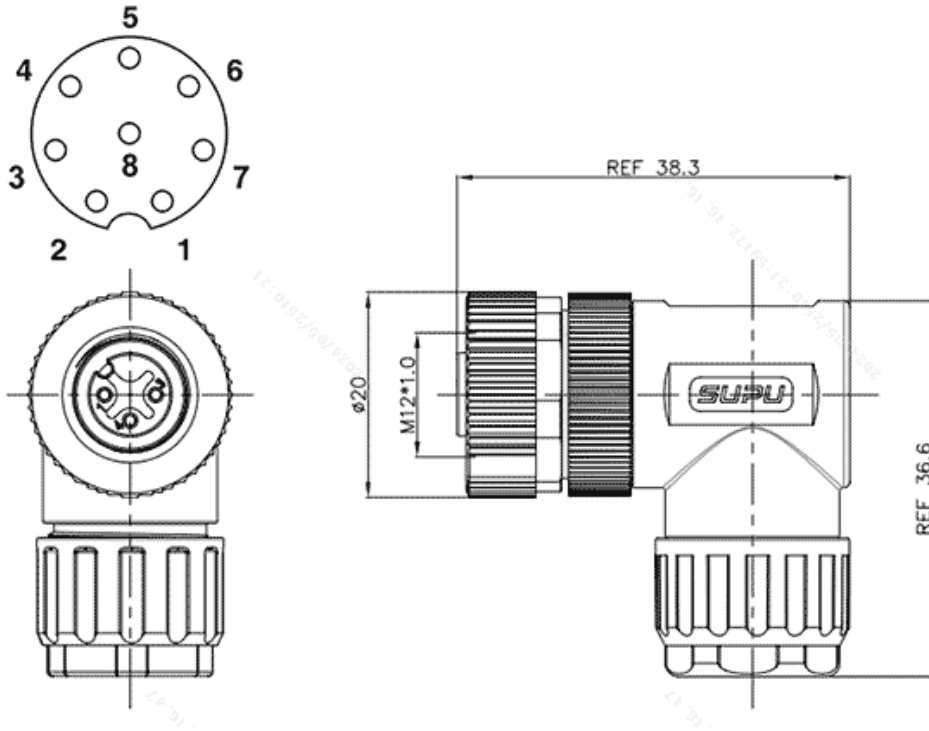

Parameters

☞ Number of connections	8
☞ Cable OD.	Field
☞ Protection Level	IP67
☞ Operating temperature range	-40~+85°C

☞ Thread type	M12X1.0
☞ Category	Hole
☞ Coding	A
☞ Shielded	NO
☞ Mechanical endurance	≥100
☞ Standards	IEC61076-2-101

Ningbo SUPU Electronics Co., Ltd.

Address: No. 150, Xinxing 4th Road, High-tech Industrial Development Zone,
Cixi City, Zhejiang Province, China

Zip code: 315303

Switchboard: +86 574-63288158

Fax: +86 574-63288170

E-mail:supucontact@supu.cn

Service Hotline: 400-626-6336



Wechat