



Product Type: Heavy-duty Connector Housing

Product Name: S10A-SEH-2B-PG16

Product Description: S10A Hoods, side entry, high construction, 2 bolts, PG16 thread

Product Size

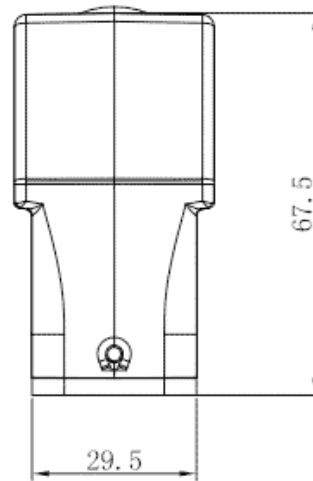
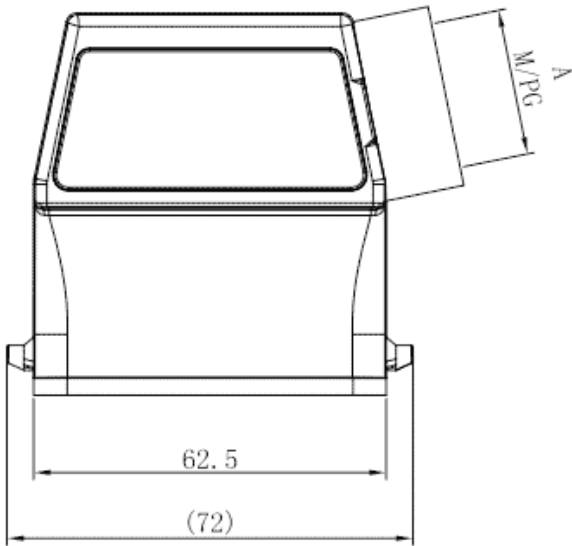

Parameters

<input checked="" type="checkbox"/> SUPU ID	S10A-SEH-2B-PG16
<input checked="" type="checkbox"/> Protection Level	IP65
<input checked="" type="checkbox"/> Operating temperature range	-40°C~+125°C
<input checked="" type="checkbox"/> Color	Grey

<input type="checkbox"/> Thread type	PG16
<input type="checkbox"/> Category	Housing
<input type="checkbox"/> Mechanical endurance	≥500

Technical data

<input type="checkbox"/> Sealing material	NBR
<input type="checkbox"/> Housing Material	Die-Cast Aluminum

Commercial data

<input type="checkbox"/> Order No	S10A-SEH-2B-PG16
<input type="checkbox"/> Packing unit	PCS
<input type="checkbox"/> Minimum order quantity	1

Ningbo SUPU Electronics Co., Ltd.

Address: No. 150, Xinxing 4th Road, High-tech Industrial Development Zone,

Cixi City, Zhejiang Province, China

Zip code: 315303

Switchboard: +86 574-63288158

Fax: +86 574-63288170

E-mail: supucontact@supu.cn

Service Hotline: 400-626-6336



Wechat

Date:2026-05-05 09:36

The right to modify data belongs to SUPU.