

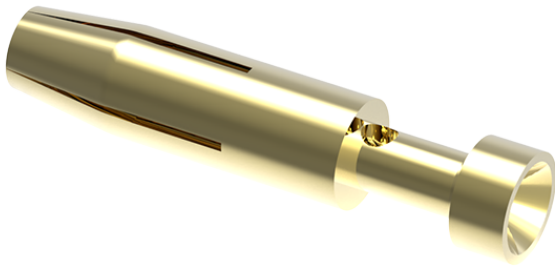

Product Type: Heavy-duty connector pins

## Product Name: SCGF-016-0.5



Product Description: 16A gold plated, Female, compatible with 0.5mm<sup>2</sup>

### Product Size

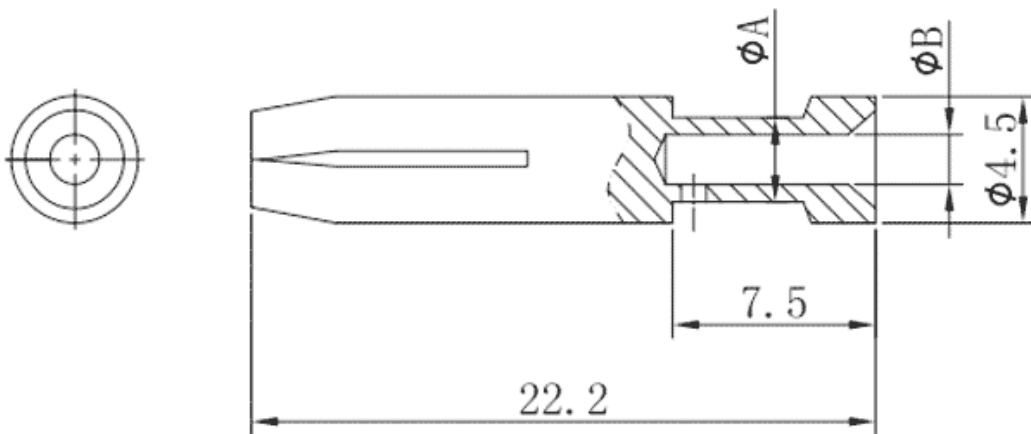

### Parameters

<input checked="" type="checkbox"/> SUPU ID	SCGF-016-0.5
<input checked="" type="checkbox"/> Operating temperature range	-40°C~+125°C
<input checked="" type="checkbox"/> Category	cold-pressed pin female terminal
<input checked="" type="checkbox"/> Connection method	Crimp terminal

<input checked="" type="checkbox"/> Mechanical endurance	≥500
--	------

## Technical data

<input checked="" type="checkbox"/> IEC Rated Current	16A
---	-----

<input checked="" type="checkbox"/> Contact/surface material	Hard-gold Plated
--	------------------

<input checked="" type="checkbox"/> Pin Material	Copper Alloy
--	--------------

<input checked="" type="checkbox"/> Contact resistance	≤1mΩ
--	------

<input checked="" type="checkbox"/> Wire Specification	0.5mm <sup>2</sup> /20AWG
--	---------------------------

## Commercial data

<input checked="" type="checkbox"/> Order No	SCGF-016-0.5
--	--------------

<input checked="" type="checkbox"/> Packing unit	PCS
--	-----

<input checked="" type="checkbox"/> Minimum order quantity	1
--	---

## Ningbo SUPU Electronics Co., Ltd.

Address: No. 150, Xinxing 4th Road, High-tech Industrial Development Zone,  
Cixi City, Zhejiang Province, China

Zip code: 315303

Switchboard: +86 574-63288158

Fax: +86 574-63288170

E-mail:supucontact@supu.cn

Service Hotline: 400-626-6336



Wechat

---

Date:2026-04-30 01:52

The right to modify data belongs to SUPU.